



## Modelling movements of Saimaa ringed seals using an individual-based approach



Lauri Liukkonen<sup>a,\*</sup>, Daniel Ayllón<sup>b</sup>, Mervi Kunnasranta<sup>a,c</sup>, Marja Niemi<sup>a</sup>,  
Jacob Nabe-Nielsen<sup>d</sup>, Volker Grimm<sup>b,e</sup>, Anna-Maija Nyman<sup>a</sup>

<sup>a</sup> Department of Environmental and Biological Sciences, University of Eastern Finland, PO Box 111, Joensuu, Finland

<sup>b</sup> Department of Ecological Modelling, Helmholtz Centre for Environmental Research – UFZ, Permoserstr. 15, 04318 Leipzig, Germany

<sup>c</sup> Natural Resources Institute Finland, Yliopistokatu 6, 80100 Joensuu, Finland

<sup>d</sup> Department of Bioscience, Aarhus University, Frederiksborgvej 399, 4000 Roskilde, Denmark

<sup>e</sup> German Centre for Integrative Biodiversity Research (iDiv) Halle-Jena-Leipzig, Deutscher Platz 5e, 04103 Leipzig, Germany

### ARTICLE INFO

#### Article history:

Received 16 June 2017

Received in revised form 31 October 2017

Accepted 1 December 2017

Available online 13 December 2017

#### Keywords:

Bycatch mortality

Conservation

Home range

Pattern-oriented modelling

*Phoca hispida saimensis*

Saimaa ringed seal

Spatially explicit individual-based model

### ABSTRACT

Movement is a fundamental element of animal behaviour, and it is the primary way through which animals respond to environmental changes. Therefore, understanding the drivers of individual movement is essential for species conservation. The endangered Saimaa ringed seal (*Phoca hispida saimensis*) lives land-locked in Lake Saimaa and is affected by various anthropogenic factors. Telemetry studies provide critical information but are insufficient to identify the mechanisms responsible for particular movement patterns. To better understand these mechanisms and to predict how changed movement patterns could influence the subspecies' spatial ecology, we developed an individual-based movement model. We divided the seals' daily routines into foraging and resting and explored how well the model captured observed home ranges and other movement metrics. Here we present the model, its predictions of home ranges and its sensitivity to model assumptions and parameter uncertainty. We used movement data from one individual to calibrate the model, but this resulted in poor predictions of home range sizes of five seals used for validation. This suggests that differences in movement paths not only reflect different landscape configurations but also differences among the individuals' state and personalities. Therefore, we separately re-calibrated the model to data from five individuals, reproducing their home ranges, habitat use and movement paths more accurately. Although ignoring many aspects of seal behaviour, the model can be applied as a tool to guide further data collection and analysis, study seal ecology, and evaluate the efficacy of various conservation measures.

© 2017 Elsevier B.V. All rights reserved.

### 1. Introduction

Understanding the drivers of animal movement is essential for preserving populations and species. Movement, as with any other behaviour, is related to the resulting payoff of that particular action. Some types of movements, such as foraging, predator avoidance, or finding a mate, may produce proximate payoff; they are all important considering the ultimate goal of individuals: reproducing and passing genes forward (Nathan et al., 2008). Even though the ultimate driving forces behind movements are similar across species, there is a wide variety in movement patterns. Movement can be oriented towards or away from certain areas (Nathan et al., 2008),

and the scale of the movements may vary from metres to thousands of kilometres depending on the species. Moreover, the individual variation within species is often remarkable (e.g. Austin et al., 2004; Ball et al., 2001; Schwarzkopf and Alford, 2002).

Animal movements can be studied using remote techniques such as telemetry (VHF or satellite tags). Use of tags enables observation of animal movements and habitat selection patterns. In addition to the location, tags can record environmental conditions or the physiological status of individuals. Telemetry techniques enable collecting large high-resolution datasets; therefore, the method has been widely applied in studying movements of species in many taxa from insects to large mammals (Chudzińska et al., 2016; Hake et al., 2001; Hart and Hyrenbach, 2009; Hedin and Ranius, 2002; Höjesjö et al., 2007; Rautio et al., 2013; Wabakken et al., 2007).

\* Corresponding author.

E-mail address: [lauri.liukkonen@uef.fi](mailto:lauri.liukkonen@uef.fi) (L. Liukkonen).

Telemetry data are typically analysed using a statistical approach that enables identification of home range sizes, activity patterns, variations in movement distances and auto-correlation in movement paths (e.g., Fleming et al., 2014, 2015). Such correlative studies help identifying relevant movement patterns such as distributions of step lengths and changes in directions, or of the time allocated to different movement-related behaviours (Morales et al., 2010; Van Moorter et al., 2009). Mechanistic models then can take these patterns into account (Pauli et al., 2013). Individual-based models (IBMs) are particularly suitable for this purpose, as they allow us to explicitly represent individual animals and their behavioural decisions. IBMs can be useful whenever variability among individuals, local interactions with other individuals or their abiotic environment, or adaptive behaviour are considered essential (DeAngelis and Grimm, 2014; Railsback and Grimm, 2012). Here, we combine telemetry data and individual-based modelling to develop a model capable of predicting Saimaa ringed seal (*Phoca hispida saimensis*) movement patterns and emergent home range behaviour. Next-generation ecological models are likely to be increasingly based on standardized sub-models that use first principles to represent mechanisms and behaviours such as foraging, movement and home range behaviour (Grimm and Berger, 2016). Therefore, our model could be used as a tool for seal conservation when integrated within a population model or coupled with other techniques.

Saimaa ringed seal is a subspecies of ringed seal that became isolated in Lake Saimaa, Finland, after the last ice age about 9500 years ago (Nyman et al., 2014). The subspecies is categorized as endangered (Liukko et al., 2016), and currently, there are only about 350 seals (Kunnasranta et al., 2016). The population may have included up to 1300 individuals at the end of the 19th century, but hunting and other direct and indirect anthropogenic factors brought the population almost to extinction (Kokko et al., 1999; Kokko et al., 1998; Sipilä, 2003). Conservation measures have been applied to tackle the problems, and the population size is slowly increasing. The main threats are currently bycatch in gillnet fishing, small population size, poor snow conditions for breeding, and human disturbances in the breeding period (Auttila, 2015; Liukkonen et al., 2017; Niemi, 2013; Valtonen et al., 2014). Conservation measures are widely based on scientific studies providing new information. In particular, several years of telemetry studies (Hyvärinen et al., 1995; Koskela et al., 2002; Kunnasranta et al., 2002; Niemi et al., 2013a; Niemi et al., 2012, 2013b) provide detailed information about Saimaa ringed seal behavioural ecology and movements.

Our model builds on the observation that seal movements consist of cycles of foraging in deep water areas ( $\geq 15$  m) and resting on haul out sites next to small islands (Vincent et al., 2017). Movements are based on both correlated random walks and unidirectional movements towards foraging areas and haul out sites. Correlated random walk has been widely used in movement modelling (Fagan and Calabrese, 2014), but it results in animals that gradually move away from their initial position (Nabe-Nielsen et al., 2013). To enable simulated seals to return to previously used haul out and foraging areas, we implemented a spatial memory component (Nabe-Nielsen et al., 2013). This addition of memory enables the formation of home ranges.

IBMs have been used to model movements of many species (Arrignon et al., 2007; Bennett and Tang, 2006; Linard et al., 2009; Nabe-Nielsen et al., 2013; Railsback et al., 1999; Reuter and Breckling, 1999) and have also been applied to conservation and management (Eisinger and Thulke, 2008; Eisinger et al., 2005; Liu et al., 2013; López-Alfaro et al., 2012; Nabe-Nielsen et al., 2010; Thulke and Eisinger, 2008). The ability to include highly detailed information about the environment and species make IBMs ideal for modelling endangered or economically important species (DeAngelis and Grimm, 2014).

The proximate purpose of our model is to simulate typical movement patterns of adult individuals to characterize the home range formation and spatial ecology of the species, but the model could ultimately be extended to study seal population dynamics under changing environmental conditions and different conservation measure scenarios. As with models for conservation biology in general, where we usually have too little data to develop models that deliver accurate predictions, our model is designed to be realistic enough for relative predictions, which allows us to rank different management options. Here, we present the model and compare its results with telemetry data. We started model development with the assumption that landscape complexity would explain the observed variation in home range sizes, and therefore parameterized the model for a single individual for which the richest data were available. After realizing that the resulting parameters did not explain the movement of other seals, we reverted to considering the distribution of the parameters of all observed individuals. We will discuss how this pragmatic and simplified approach relates to the unresolved problem of extracting movement parameters from tracking data of individuals with different personalities, moving in complex environments.

## 2. Materials and methods

### 2.1. Biological background

Here, we provide the background information that guided model design. Ringed seal ecology is relatively well known, but much of the knowledge does not apply to the Saimaa ringed seal, which lives in a freshwater environment that differs considerably from the oceanic environment inhabited by other subspecies. Adult Saimaa ringed seals have home ranges of around 90 km<sup>2</sup> on average (Niemi et al., 2012), which is remarkably smaller than home ranges reported in marine ringed seals (e.g., Born et al., 2004; Oksanen et al., 2015). For example home ranges of individual Baltic ringed seals may cover an area of over 12 000 km<sup>2</sup> (Oksanen et al., 2015), which is almost three times larger than the total surface area of Lake Saimaa. In addition to compact home ranges, seals' sedentary behaviour is apparent from strong haul out site and breeding site fidelity (Koivuniemi et al., 2016; Valtonen et al., 2012). Saimaa ringed seals reach sexual maturity at the age of 4–6 years (Auttila et al., 2016) and give birth in subnivean snow lair during period from mid-February to mid-March after 11-month gestation period (Sipilä, 2003). After the breeding, mother-pup pairs stay in close vicinity to the lair site until the pup is weaned at the age of approximately 3 months (Hyvärinen et al., 1995; Kunnasranta, 2001; Niemi et al., 2013a). Males and females that are not breeding also use snow lairs for moulting and resting in the winter time (Helle et al., 1984). When weather gets warmer in the spring, lairs collapse and seals start to haul out first on the ice, and later on terrestrial platforms. These are typically rocks located on the shoreline of small islands, but not in the vicinity of the mainland. According to telemetry studies, Saimaa ringed seal individuals use an average of 13 haul out sites during the open water season (Niemi et al., 2013a). Haul out takes over half of seals' time during the moulting period from late April to early June, with activity peaking in the afternoon when the temperature is highest, which is reported to be beneficial for moulting (Boily, 1995; Paterson et al., 2012). Outside of the moulting season, haul out takes no more than 20% of total time and is mainly nocturnal. Studies suggest that night time haul may be an adaptation to prey fish behaviour and disturbance, which is more frequent during the day (Hyvärinen et al., 1995; Kunnasranta, 2001; Kunnasranta et al., 2002; Niemi et al., 2013a).

Haul out is affected by many environmental factors (i.e., amount of solar radiation, wind, temperature and cloud cover), physiolog-

ical status, and possible disturbance (Carlens et al., 2006; Moulton et al., 2005; Moulton et al., 2002; Niemi et al., 2013a). Especially in the case of the Saimaa ringed seal, disturbance by humans is an important factor affecting haul out, as the lake is a popular place for recreational activities (Niemi et al., 2013a). In addition to terrestrial sites, resting can also take place in water. Seals have been observed to make consecutive long duration dives that are suggested to be associated with resting (Hyvärinen et al., 1995; Kunnasranta et al., 2002). Sleeping dives usually take place next to haul out sites and are more likely to occur when the weather is not optimal for haul out, e.g., when it is raining. Still, even though resting is possible in water, haul out remains an important part of a seal's daily activities throughout the year, with a peak centred around the breeding and moulting seasons (Kunnasranta et al., 2002).

There is seasonal variation in Saimaa ringed seal feeding patterns. Seals' feeding activity is reduced during spring due to the breeding, nursing and moulting seasons. In late summer, seals need to forage actively to gain weight for the upcoming winter, as blubber is needed to provide protection from harsh thermal conditions. Seals are generalists that feed mainly on small schooling fish species, such as perch (*Perca fluviatilis*), roach (*Rutilus rutilus*), vendace (*Coregonus albula*), smelt (*Osmerus eperlanus*) and ruff (*Gymnocephalus cernuus*) (Auttila et al., 2015; Kunnasranta et al., 1999) and use same water regions for feeding throughout the year (Auttila et al., 2015). Adult seals prefer deep water ( $\geq 15$  m) foraging areas, where vendace and smelt, that are rich in fat content, are found outside spawning season (Kunnasranta et al., 1999). Other prey species are abundant in shallow areas throughout the year, and therefore seal foraging is not only limited to deep-water areas. The quantity of prey fishes is classified as medium to very high for perch and smelt in northern parts of the lake (Valkeajärvi et al., 2010) and food is not considered to be a limited resource (Auvinen et al., 2005).

Saimaa ringed seals have not been considered to be threatened by predators. However, recent findings have shown medium-sized carnivores (red fox *Vulpes vulpes* and raccoon dog *Nyctereutes procyonoides*) to be interested in ringed seal lairs (Auttila et al., 2014) and some pups are shown to be killed by a red fox (Auttila, 2015). Adult individuals are likely able to escape from predators more efficiently than pups, which are more prone to predation. Nevertheless, predation forms presumably only a minor part of Saimaa ringed seal mortality and it is focused only on pups during winters with poor breeding conditions (e.g. inadequate snow cover).

## 2.2. Study area

Lake Saimaa (surface area 4400 km<sup>2</sup>, mean depth 12 m) consists of several basins connected via narrow straits (Kuusisto, 1999). We focused on two water basins, namely Haukivesi and Joutenvesi (Fig. 1), together forming one of the most important breeding areas and it is inhabited by approximately 100 seals (Metsähallitus, 2016) comprising almost one-third of the estimated population.

## 2.3. Telemetry data

Data used in model development were obtained by equipping six seals with GPS/GSM tags (Sea Mammal Research Unit, St. Andrews University, UK). Seals were tagged in the Haukivesi basin between years 2007–2011 during the annual moulting season in spring. Neither of the two tagged females were pregnant or nursing offspring during the study season to our knowledge. Tags were set to record dive data (depth, duration), and to determine the location every 20 min if the seal was in the water and every 60 min if it was hauled out. A seal was considered to be hauled out if the wet/dry sensor on the tag had been dry for 10 min; the haul out was considered to have ended when the sensor had been wet for 40 s. In the

first phase of pattern-oriented model development and parameterization, GPS-telemetry data from one adult male (ER11; 3822 relocations, tracking duration 125 days, mean swimming speed during the open water season; 424.10 m/20 min) from the study area were used to develop and calibrate the model. This individual had the highest resolution data in the database (Saimaa ringed seal telemetry database, University of Eastern Finland 2015). In the second phase, additional data from five adult individuals (HE07♀: 3003 relocations, 191 d, 367.15 m/20 min; KJ07♂: 4475 relocations, 218 d, 518.94 m/20 min; OL10♀: 2155, 180 d, 302.27 m/20 min; TO09♂: 3254 relocations, 194 d, 505.44 m/20 min; and VI09♂: 4618 relocations, 199 d, 281.88 m/20 min) were used for model validation and final calibration of one parameter (see Section 2.5). All data were limited to the open water season and constrained to the same temporal resolution as the shortest tracking period, except for the initial calibration individual (ER11), whose data were fully used. AdehabitatLT package (Calenge, 2011) in R (R Development Core and Team, 2011) was used for calibration. Additionally, datasets of 18 seals were used to develop probability distribution for the speed parameter (see section 4.3 Model sensitivity & Appendix E in Supplementary material). These datasets were not used in model calibration.

## 2.4. The model

The model description follows the ODD (Overview, Design concepts, Details) protocol (Grimm et al., 2006; Grimm et al., 2010). Its implementation in NetLogo 5.2.0 (Wilensky, 1999) is available in the Supplementary Material. In addition, in the Supplementary Material (Appendix A in Supplementary material), we provide a TRACE document ("TRANSPARENT and Comprehensive model Evaluation") (Augusiak et al., 2014; Grimm et al., 2014; Schmolke et al., 2010) containing evidence that our model was thoughtfully designed, correctly implemented, thoroughly tested, well understood, and appropriately used for its intended purpose.

### 2.4.1. Purpose

The purpose of the model is to simulate seal movement patterns based on assumptions regarding resting and foraging behaviour.

### 2.4.2. Entities, state variables, and scales

The area represented in the model (Haukivesi and Joutenvesi basins) is 762 km<sup>2</sup>. The model world consists of a grid of 1000 × 1000 cells, or patches; each patch represents an area of 0.00297 km<sup>2</sup> (54.5 m × 54.5 m). Model entities are habitat patches, seal and rock agents. Habitat patches are either land or water patches (land?; true/false). Some of the land patches were further characterized as island patches (island?; true/false). Land areas larger than 0.01 km<sup>2</sup> and less than 2.98 km<sup>2</sup> are considered islands in the model. The minimum size of an island preferred for haul out is reported to be 0.0002 km<sup>2</sup> (Niemi et al., 2013a) but was increased to 0.01 km<sup>2</sup> in the model to keep the habitat as realistic as possible while taking into account the limited resolution of the map. Water patches are divided into three categories: Deep water ( $\geq 15$  m), shallow water (<15 m) (deep; true/false), and water suitable for haul out sites (stone-place?; true/false). These are water patches next to islands where rocks are created, as such areas are regarded as suitable haul out sites. The number of potential haul out sites in nature is unknown and was thus estimated from haul out data and home range sizes. Observed average number of 13 haul out sites per seal per average home range size was extrapolated to the study area. Consequently, a total of 121 haul out sites were randomly created at initialization; this number is in accordance with an earlier telemetry study where it was observed that eight GPS/GSM tracked individuals used in total 104 different haul out sites in the same area (Niemi et al., 2013a). The sites used as starting points for seal agent

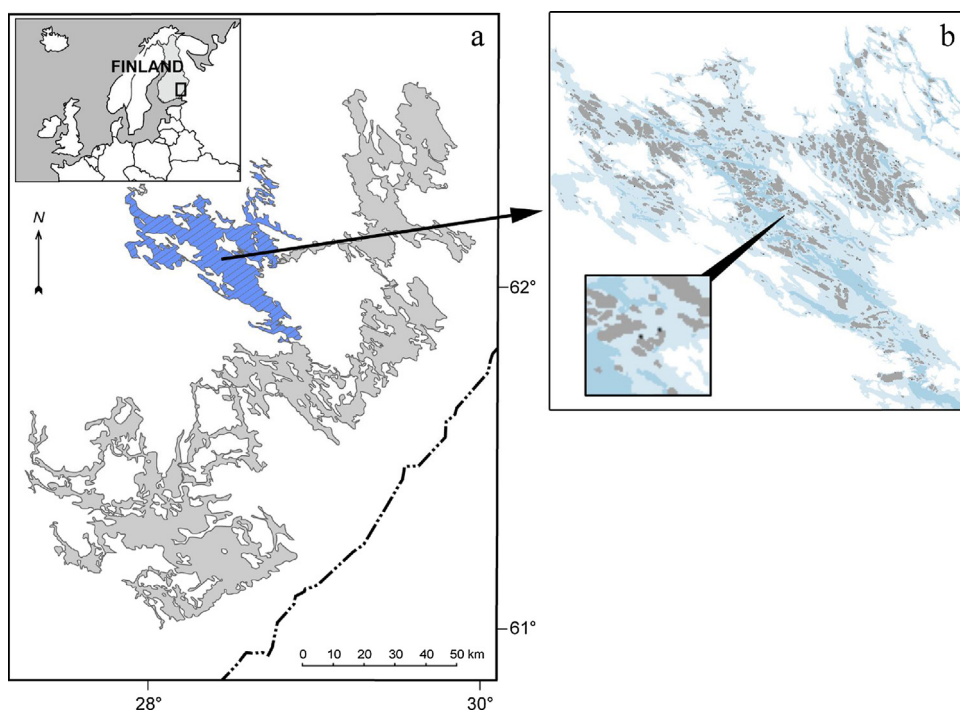

**Fig. 1.** Map of Lake Saimaa showing the Haukivesi and Joutenvesi basins (in blue) (a), which were implemented in NetLogo (b) (blue = water, dark blue = deep water (>15 m), white = land (>298 ha), grey = islands (1–298 ha), black dot = haul out site). Permit MML/VIR/TIPA/5012/17 © National Land Survey of Finland. (For interpretation of the references to colour in this figure legend, the reader is referred to the web version of this article.)

were characterized only by their coordinates (init-site; x: 0–1000, y: 0–1000).

A seal is characterized by its age (age-in-months; 48 months), exhaustion level (exhaustion; 0.1–0.999), movement variables, including distance travelled in the time step (step-length; randomly set from a normal distribution, in metres) and direction of movement (turning-angle; 0–360°), and memory variables, including spatial memory of haul out sites and deep water areas (stone-cors; 0–100 sites, deep-cors; 0–100 sites), and the memory value of each visited haul out site (memory-stones-list; 0.1<sup>-7</sup>–0.99); please note that due to memory decay model seals rarely remembered more than 5 sites. Only one seal is simulated at a time.

The time step is 20 min when the seal is swimming and 60 min when it is hauled out. This matches the resolution of data recorded with GPS/GSM tags. The ice-covered season (January–March) is omitted, as seal is moving in a smaller area within its home range (Kelly et al., 2010). The simulation starts at the beginning of April and is first run for 12.5 months; during the last 0.5 months of this period, the seal has its initial site as the only target for haul out. This warm-up period enables the seal to have some haul out sites and deep water areas in its memory before the actual data collection begins in the middle of consecutive April when the warm-up period of 12.5 months have passed. Results were then recorded after this warm-up period for duration of 4.17 months for individual ER11 and 5.96 months for the rest of the individuals.

#### 2.4.3. Process overview and scheduling

The processes described below are executed in the same order in each time step (Fig. 2). Here, only summary descriptions of the processes are provided; see section 2.4.7 (Submodels) for details. Submodel names are given in italics:

(1) *Update time step* – Length of time step is updated, depending on the seal's activity.

- (2) *Update age* – The seal's age (in months) is updated. Ice-covered season (January–March) is skipped by adding 3 months to the seal's age.
- (3) *List coordinates* – Coordinates of the seal's location are added to a list for home range calculations.
- (4) *Decay memory* – Memory values of the visited haul out sites are updated as memory decays over time.
- (5) *Remember haul outs* – If the seal is currently hauled out, the site is added to memory.
- (6) *Rest* – If the seal's exhaustion is above the moving threshold (see section 2.4.7 Submodels, Table 1) or there is a suitable haul out site near-by, it rests. The seal starts moving again when exhaustion decreases below the moving threshold. Movement mode is set to 1 (sets a deep water target patch) if there are deep water patches in the seal's memory and to mode 2 (correlated random walk) if that is not the case.
- (7) *Move* – There are three different movement modes: movement to a previously visited deep water patch (mode 1), correlated random walk (mode 2), and movement towards a haul out site (mode 3).
- (8) *Write results/Update plots* – Output files are written, and plots are updated.

#### 2.4.4. Design concepts

The design concepts *Interaction* and *Collectives* do not apply to this model. *Adaptation*, *Objectives*, and *Prediction* are represented implicitly in the imposed haul out behaviour.

**2.4.4.1. Basic principles.** Seal movements consist of cycles of foraging in deep water areas and resting on haul out sites. The seal remembers visited haul out sites and foraging areas to some extent, which has influence on the space use. In addition, we implicitly represent bioenergetics as exhaustion, which requires haul out and increases with foraging time.

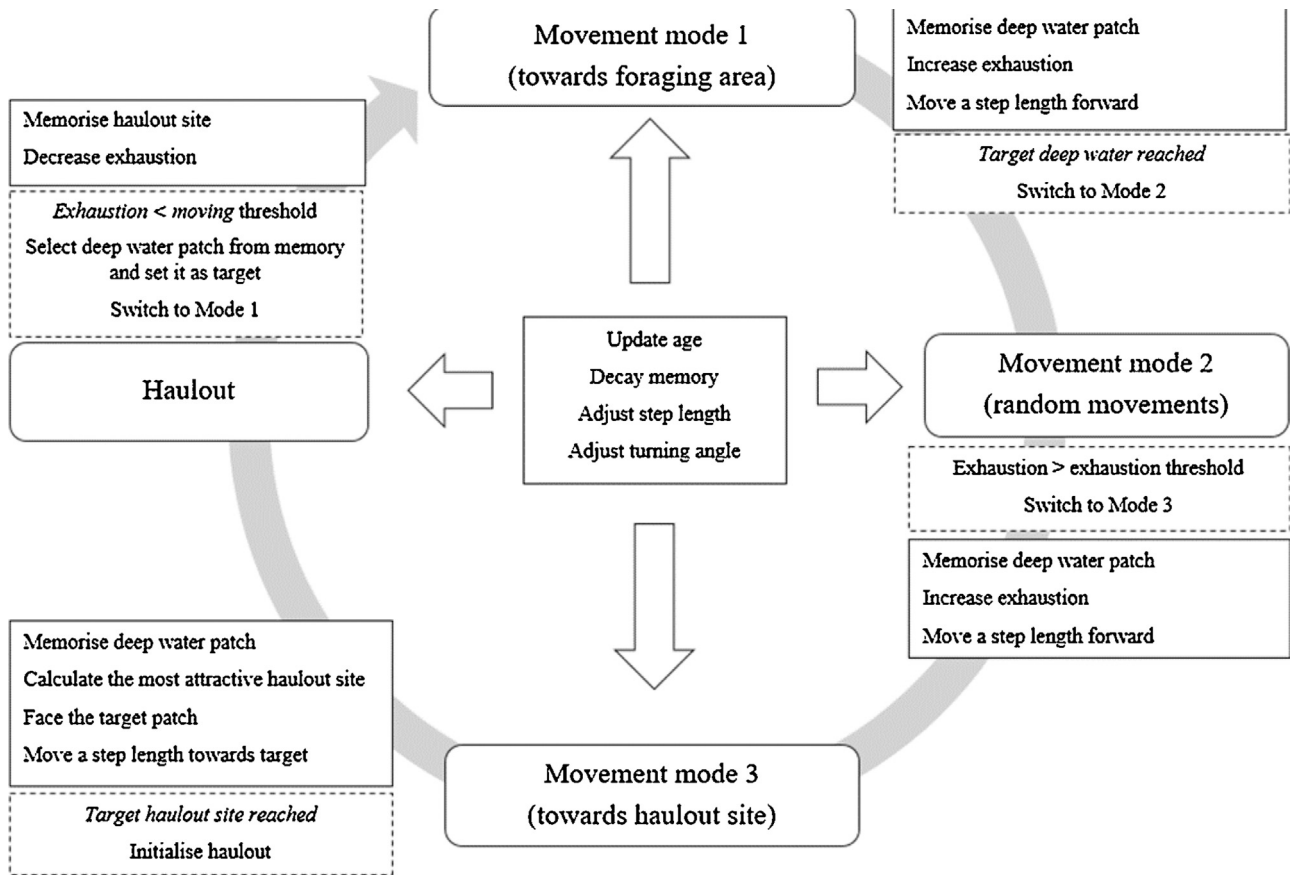

**Fig. 2.** A simple flow diagram of processes in the Saimaa ringed seal movement model. Processes in the middle box are performed with each time step; depending on the movement mode, different additional procedures are executed. Boxes with dashed lines indicate the state criteria when the movement mode is switched.

**Table 1**  
Model parameters and their meanings, values and units. In addition, the procedures where the parameters are used are listed. All parameter values were obtained through calibration.

Parameter name	Meaning	Value	Units	Procedure where used
exhaustion-threshold	Determines when to head to a haul out site	0.500	–	Move
moving-threshold	Determines when to start moving after resting	0.100	–	Rest Sleep-in-water
exhaustion-recovery-rate	The rate at which exhaustion decreases when resting	0.660	per 60 min	Rest Sleep-in-water
ref-mem-decay-rate	Memory decay rate	0.210	per 60 min	Decay-memory
exhaustion-rate-adults	Exhaustion rate	0.089	per 20 min	Set-exhaustion-rates
mean-speed-adults	Mean speed value	100.000–350.000 depending on the individual used in parameterization	m/20 min	Adjust-speed
sd-speed-adults	Standard deviation of speed	123.100	m/20 min	Adjust-speed
mean-turning	Mean turning angle	0.109	degrees	Adjust-turning-angle
sd-turning	Standard deviation of turning angle	15.680	degrees	Adjust-turning-angle
land-distance	The distance how far seal can see when avoiding land	3.458	grid cells	Avoid-land-decision
ho-distance	Maximum distance to haul out site, which initializes resting if seal is not exhausted	6.000	grid cells	Move
ho-exhaustion-limit	Exhaustion must exceed the parameter value to initialize resting if seal is not exhausted	0.150	–	Move

2.4.4.2. *Emergence.* Movement patterns, as characterized by the size of animal home ranges and time spent either moving or hauled out, emerge partly from animal personalities. Hence, in the model, different personalities appear as different speed parameter values for individual seals. Furthermore, the capacity and permanence of the seal’s memory of visited haul out sites and foraging areas plays a role in the emergence of movement patterns. In addition, the location and number of potential haul out sites in the area affect the seal’s movements in the model.

2.4.4.3. *Learning.* The seal learns about its habitat by remembering visited haul out sites and deep water grid cells.

2.4.4.4. *Sensing.* The seal senses and avoids land in its moving direction. It also senses if it is in a deep water area or if there is a haul out site nearby, and it knows the distance to visited haul out rocks.

2.4.4.5. *Stochasticity.* Step length in all movement modes and moving direction in movement mode 2 (correlated random walk) are

drawn from truncated normal distributions. In addition, the positions of haul out sites are randomly assigned at initialization. Furthermore, haul out sites and deep water foraging areas that seal uses may differ among replicates; this introduces another factor creating stochasticity.

**2.4.4.6. Observation.** Position, distance from home (km), movement duration (h), and duration of haul outs (h) are measured every time step. Home refers to the location where the seal is initialized.

#### 2.4.5. Initialization

The world is created by importing GIS shape files for water, deep water ( $\geq 15$  m) and land areas. A total of 121 haul out rocks (see section 2.4.2 *Entities, state variables, and scales* for estimation of number of haul out sites implemented) are randomly created near islands. One seal is created and positioned on a user-defined haul out site, set to resting mode, and given an empty memory except for the current haul out site, an exhaustion of 0.998 (maximum exhaustion 0.999) and an age of three months.

#### 2.4.6. Input data

The model does not include input of data representing time-varying environmental drivers.

#### 2.4.7. Submodels

Model parameters are listed in [Table 1](#).

**2.4.7.1. Update time step, age and time.** The time step is set to 20 min if the seal is moving and to 60 min if it is hauled out. Age and current time are updated accordingly.

**2.4.7.2. List coordinates.** Coordinates of the seal's location are stored in a list for home range estimations. Because the time step is three times longer (60 min) when hauled out, every pair of haul out site coordinates are listed three times to avoid bias in the results by emphasizing relocations when moving. In addition, only 25% of movement coordinates are listed to match the resolution of telemetry data. GPS/GSM tags fail to connect to the satellites occasionally, and therefore, the locations may not be obtained every 20 min as programmed.

**2.4.7.3. Decay memory.** The seal remembers visited haul out sites. However, memory decays over time (i.e., seal forgets). The last haul out site on the list will be removed if there are already 100 sites in the memory or if the memory value for a site is  $<10^{-8}$ . Memory decay is represented according to [Nabe-Nielsen et al. \(2013\)](#):

$$M[c]_{t+1} = M[c]_t - (M_R \times M[c]_t \times (1 - M[c]_t)),$$

where  $t$  is time in units of time steps,  $M[c]$  is the memory of a location  $c$  (unitless), and  $M_R$  is the reference memory decay rate (1/h).

**2.4.7.4. Remembering haul outs.** If the seal is hauled out, the site is added to its memory and given a memory value of 0.99. In cases where the site is already in the seal's memory, the entry representing the earlier visit is removed.

**2.4.7.5. Rest.** If the seal is hauled out or sleeping in water, exhaustion decreases following:

$$E[c]_{t+1} = E[c]_t - \left( R_R \times E[c]_t \times \left( 1 - \frac{E[c]_t}{E[c]_{max}} \right) \right),$$

where  $t$  is time,  $E[c]$  is the exhaustion level,  $E[c]_{max}$  is the maximum of exhaustion level, and  $R_R$  is the exhaustion recovery rate. If exhaustion falls below the moving threshold, the exhaustion level

is set to 0.1 and either movement mode 1 or 2 is selected (see below for definition of movement modes).

#### 2.4.7.6. Move.

**2.4.7.6.1. Movement modes.** There are three movement modes that the seal can perform. After hauling out (during which movement mode is *false*), the seal heads to a deep water patch to forage (mode 1); having reached the target deep water grid cell, it starts moving by correlated random walk (mode 2). After foraging, the seal selects haul out site based on distance and memory factors and goes there to rest (mode 3). The choice between these three movement modes is based on the state variable *exhaustion*. When the seal is hauled out, its level of exhaustion decreases; once it decreases below the *moving threshold*, either movement mode 1 or 2 is selected. The seal heads to an earlier visited deep water patch (mode 1) if it knows any, or starts moving by correlated random walk (mode 2) if it has not visited any deep water areas yet (e.g., at the initialization of the model). Once a deep water area is reached, movement mode 2 is set (provided that the seal was not in mode 2 already). When *exhaustion* reaches the level of parameter *exhaustion threshold*, movement mode 3 is selected and the seal goes to a haul out site to rest and the movement mode is set to *false*. Alternatively, the seal can also rest when there is a suitable haul out site within distance of the parameter *ho-distance*. This heuristic assumption of allowing the seal to haul out on near-by haul out sites, even if not fully exhausted, seems appropriate as it allows the seal to save energy. If *exhaustion* exceeds its maximum value before reaching a haul out site, the seal sleeps in water until exhaustion decreases low enough and it starts moving again. The *sleep in water* procedure is not possible in deep water.

The following processes are common to all movement modes and are performed before moving in the order listed:

- (1) *Adjust step length* – Step length is drawn from a normal distribution with its mean set to the parameter *mean-speed-adults* and its standard deviation to *sd-speed-adults*. Minimum step length is set to 0.1 to avoid seals moving backwards.
- (2) *Adjust turning angle* – Turning angle is drawn from a normal distribution with its mean set to the parameter *mean-turning* and its standard deviation to *sd-turning*.
- (3) *Set exhaustion rate* – Exhaustion rate is set to the value of parameter *exhaustion-rate-adults*.
- (4) *Update exhaustion level* – Exhaustion level increases in every movement step according to:

$$E[c]_{t+1} = E[c]_t + \left( Exh_R \times E[c]_t \times \left( 1 - \frac{E[c]_t}{E[c]_{max}} \right) \right),$$

where  $Exh_R$  is the exhaustion rate, and  $E[c]$  is the exhaustion level (unitless).

- (5) *Remember deep* – If the seal is in a deep water patch, the patch is added to the seal's memory. Earlier visits to that patch are removed from memory. If a target deep water patch is within the step length or a shorter distance, the seal moves there.

**2.4.7.6.2. Targeted vs. non-targeted movements.** Earlier described movement modes can be further divided into targeted and non-targeted moving. In *non-targeted moving*, the seal moves by correlated random walk (mode 2). The turning angle is updated every time step, land is avoided if necessary, and a step is taken forward. In *targeted moving*, movement is directed either towards a deep water foraging area (mode 1) or a haul out site (mode 3). If the seal is moving towards a deep water area, one deep water grid cell is randomly selected from the seal's memory

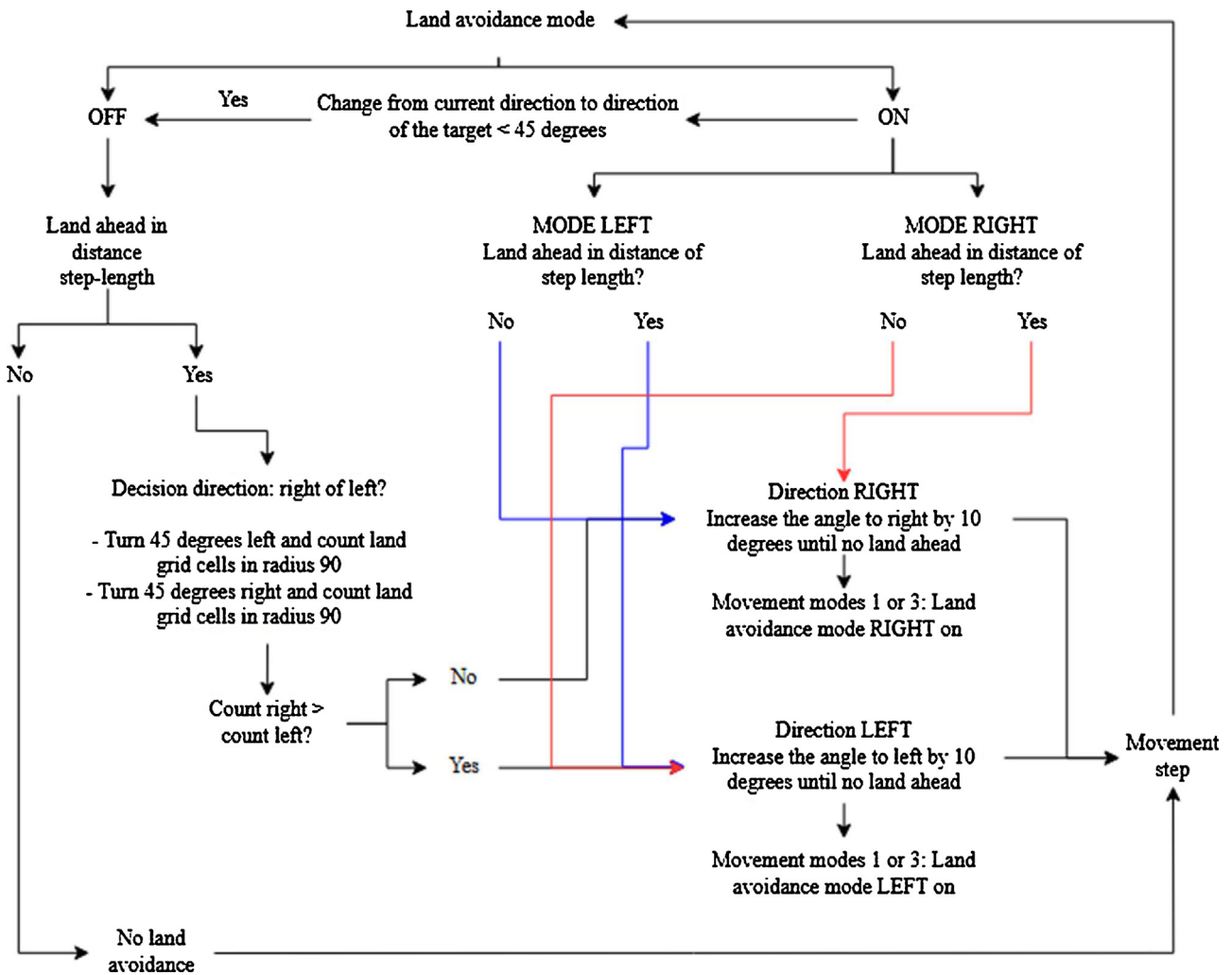

Fig. 3. Flow diagram of land avoidance decision-making in the Saimaa ringed seal movement model.

and set as a target. The selection of the target haul out site is based on the distance from the seal's position and time when the seal last visited that site, as described below.

*Calculate haul out site attraction value* – Target haul out site is chosen by calculating the attraction values of previously visited haul out sites as follows:

$$A[c]_t = \frac{1}{M[c]_t} \times D[c]_t$$

where  $A[c]$  is the attraction value of the site,  $M[c]$  is the memory value of the site (see submodel *decay-memory*), and  $D[c]$  is the distance of visited haul out sites to the seal. The haul out site with the smallest value is chosen as a target.

**2.4.7.6.3. Avoid land.** The design of the land avoidance procedure used the approach described by Dalleau (2013). A flow diagram of the procedure is presented in Fig. 3. This submodel consists of four different procedures:

- (1) *See if there is land ahead* – The seal checks if there is land ahead within one step length or less. Distances smaller than one step length are needed to avoid the seal jumping over narrow land areas.
- (2) *Avoid land decision* – Land avoidance direction selection, i.e., left or right, is based on two steps. First, the seal turns 45° left and right and calculates which turning direction has less land within an angle of 90° and a radius defined by the parameter *land-*

*distance*. If there is an equal amount of land in both directions, the moving direction is chosen randomly.

- (3) *Avoid land right* – First, the seal checks if there is land ahead in its moving direction (*see if land ahead*). If not, the seal turns counter-clockwise in steps of 10° until it detects land in its moving direction. Then, the seal chooses the previous turning direction and takes a step forward. This makes the seal follow the shoreline of an island. If the *Avoid land decision* was set to right at the beginning of this procedure, the seal will avoid it from the right side of the detected land. It turns clockwise in steps of 10° until there is no land ahead and then takes a step forward. If the seal has already turned 360° and has not encountered land, it takes a step towards the set target. Sometimes the step length is long enough to make the seal encounter land in every direction. In such case, step length is reduced by 50% and the land avoidance procedure is repeated; this reduction is repeated until the seal can move. When the angle between seal's current heading and its target is small ( $\leq 45^\circ$ ), land is most likely avoided. If there is no land ahead, and the angle between heading and target is  $\leq 45^\circ$ , land avoidance mode is turned off.
- (4) *Avoid land left* – This procedure is identical to *avoid land right*, except that the seal turns clockwise if there is no land in its moving direction and counter-clockwise if there is. This makes the seal avoid land from the left side.

2.4.7.7. *Write results/Update plots.* The output variables *distance from home* and *moving duration*, and additionally coordinates of seal movements for home range estimations are written into an output file. Plots of the seal's distance from home, moving duration and haul out duration are updated every time step.

## 2.5. Parameterization

The model was developed, parameterized and tested following the pattern-oriented framework (Grimm and Railsback, 2012; Grimm et al., 2005) in two distinct phases. Nine parameters were inversely determined (Grimm and Railsback, 2012; Wiegand et al., 2003) via calibration of two movement patterns obtained from one tracked male (ER11; see section 2.3). The patterns used were *moving duration* and *distance from home* and these were measured from both simulated and telemetry tagged seals. Home represents the location where the seal was captured for telemetry data, but in the model it refers to the initial position of the seal. *Distance from home* was recorded at each time step, and *moving duration* was measured when the seal reached haul out site after a foraging bout. Parameter estimation was performed in two rounds: first, parameters were varied over a large range (exhaustion-rate-adults; 0–1.00, mean-speed-adults; 0–600.00, sd-speed-adults; 0–200.00, mean-turning; –10.00–10.00, sd-turning; 0–180.00, ref-mem-decay-rate; 0–1.00, land-distance; 1.00–10.00); second, they were fine-tuned by being varied over a narrower range around the optimal values identified in the first round (exhaustion-rate-adults; 0.05–0.09, mean-speed-adults; 100.00–300.00, sd-speed-adults; 100.00–200.00, mean-turning; –5.00–5.00, sd-turning; 10.00–60.00, ref-mem-decay-rate; 0–0.35, land-distance; 3.00–10.00). In both cases, a Latin hypercube sampling design (Iványi et al., 1979) was used by means of the *tgp* R package (Gramacy, 2007; Gramacy and Taddy, 2010) to draw 800 parameter sets from the entire parameter space defined by the nine parameters selected for calibration. For each parameter set, the model was run ten times; means of the output variables' medians were calculated and compared to telemetry data to assess model performance. Deviation from telemetry data was calculated according to:

$$\text{Deviation} = \frac{|\text{Obs} - \text{Sim}|}{\text{Obs}}$$

where *Obs* is the observed median for the two variables calculated from the telemetry data, while *Sim* is the mean of the model runs' medians of the given output variables.

Based on the first round of simulations and following a filtering approach (Wiegand et al., 2004), the parameter sets having a deviation for the *moving duration* variable below 15% were selected; among the sets passing this first filter, only the parameter sets presenting a total combined deviation for both patterns below 500% were retained to determine the range for the second round of simulations. In this stage, the parameter set producing the lowest total deviation from telemetry data was chosen.

Since the duration of haul out events is influenced only by exhaustion recovery rate, we calibrated this parameter alone via a sensitivity experiment (parameter range 0–1.00, steps 0.01). Exhaustion recovery rate was calibrated to allow seals to haul out for the time observed by Niemi et al. (2013a). Haul out does not include any stochastic elements among runs; therefore, one run per parameter value was performed. The variation within runs arises from the state of an individual entering haul out (i.e., exhaustion level). The parameter value producing the lowest deviation in comparison to telemetry data was chosen.

In order to enable seal haul out not only when it is exhausted but also when there is a suitable haul out site nearby, parameters *ho-distance* and *exhaustion-ho-limit* were added (see Table 1 for

parameter description) and calibrated (*ho-distance*; values tested 0.1, 2.0, 4.0, 6.0, 8.0, 10.0; *exhaustion-ho-limit*; values tested 0.10, 0.15, 0.20, 0.25; 0.30). *Ho-distances* determines the distance from which a seal can observe a haul out site and *exhaustion-ho-limit* sets the minimum value of exhaustion at which haul-out can be initialised to avoid a seal starting to haul out right after a previous haul out event. Parameters were calibrated to match the observed pattern of calibration individual and the parameter values resulting in the highest number of replicates that did not statistically differ from the observed datasets (one-way ANOVA,  $p > 0.05$ ) were selected.

The model was not able to reproduce the *distance from home* pattern of the five individuals used for validation (see results Section 3.2). Since the global sensitivity analysis (see results Section 3.3) indicated that the *mean-speed-adults* parameter had the strongest effect on this model output, we calibrated this parameter separately for the five individuals used for model validation (tested ranges: ER11; 60–210 m/20 min, HE07; 250–400 m/20 min, KJ07; 250–400 m/20 min, OL10; 10–160 m/20 min, TO09; 110–300 m/20 min, VI09; 20–250 m/20 min). Simulations were replicated ten times. The parameter values resulting in the highest number of replicates that did not statistically differ from the observed datasets (one-way ANOVA,  $p > 0.05$ ) were selected.

## 2.6. Sensitivity analyses

We conducted a global sensitivity analysis to identify the model parameters with the strongest influence on model outputs. We applied the variance-decomposition technique of Sobol (1993) to decompose the model outputs' variance into variances attributable to each input parameter while also evaluating the interaction between parameters. Sobol first-order sensitivity indices ( $S_i$ ) measure the effect of varying a focus parameter alone but averaged over variations in other input parameters, thus providing information on the average reduction of output variance when the parameter is fixed. The total-effect indices ( $S_{Tij}$ ) measure the contribution to the output variance of the focus parameter, including all variance caused by its interactions, of any order, with any other input parameters. We used the *sensitivity* R package (Pujol et al., 2016), which implements the Monte Carlo estimation of the Sobol's indices using the improved formulas of Jansen (1999) and Saltelli et al. (2010). The number of tested settings was given by  $m \times (p + 2)$ , where  $m$  is the size of the Monte Carlo sample matrix and  $p$  is the number of parameters to analyse.

We selected seven parameters that varied over the following ranges:  $Exh_{\text{adult}}$  (exhaustion-rate-adults; 0.01–0.25),  $sl_{\text{adult}}$  (mean-speed-adults; 10–600),  $slSD_{\text{adult}}$  (sd-speed-adults; 10–600),  $ta_{\text{adult}}$  (mean-turning; –10 to +10),  $taSD_{\text{adult}}$  (sd-turning; 10–100),  $M_R$  (ref-mem-decay-rate; 0–1), and  $Vis$  (land-distance; 1–10). We chose a sample matrix of size 400, and Sobol first-order and total-effect indices were computed for each parameter from a total number of runs of  $400 \times (7 + 2) = 3600$ .

The sensitivity analysis examined two model outputs: *moving duration* and *distance from home*. Because the locations of haul out sites most likely influence the patterns, we simulated each of the parameter combinations keeping the same haul out site positions through all runs. The simulations were performed for 4.066 months as long as the movements of the calibration individual were monitored in 2011. Model runs were replicated 2 times.

To study the effects of the number and location of haul out sites, we ran simulations initialising the model with 120, 240, 480, 960 and 1920 rocks. Haul out sites were either kept in the same locations between replicates or randomly distributed at the beginning of each replicate. In both scenarios, simulations were replicated five times at each haul out site density. Simulations were initialised from the location where the individual used in model parameter-



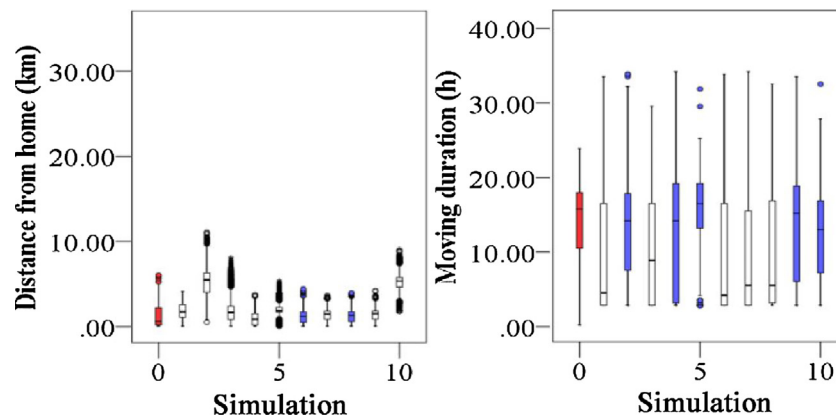

**Fig. 4.** Distance from home (km) and moving duration (h) data of the Saimaa ringed seal individual (ER11) used for calibration compared to 10 simulation replicates (0 = observed data from seal individual (red colour), 1–10 = simulation replicates). Simulations with no statistical differences from observed data (one-way ANOVA,  $p > 0.05$ ) are marked with blue. (○ = outliers  $1.5 \times$  inter quartile range (IQR) or more above the third quartile or  $1.5 \times$  IQR or more below the first quartile, \* = outliers  $3 \times$  IQR or more above the third quartile or  $3 \times$  IQR below the first quartile.) (For interpretation of the references to colour in this figure legend, the reader is referred to the web version of this article.)

ization (ER11) was captured in the field survey, and the model was run for 4.17 months. Furthermore, we examined the extent to which the initial selection of haul out sites and deep water areas during the warm-up period influenced model outputs. To do this, the seal was initialised having five fixed haul out sites and deep water patches in its memory; the obtained results were compared to simulations run using the normal settings, i.e., empty memory. Simulations were replicated 15 times, and the model was run for 4.17 months in each replicate.

### 3. Results

#### 3.1. Calibration

Results of the 10 replicates with the optimal parameter set (Table 1) indicated that the model reproduced the range of values of the two tested patterns reasonably well. Regarding the *distance from home* variable, 2 out of 10 replicates did not statistically differ from the field data (mean of the model replicates' means; 2.15 km, range 0.90–5.20 km), and in the case of *moving duration* pattern, 5 out of 10 replicates did not differ from the calibration dataset (mean of the model replicates' means; 11.68 h, range 9.11–15.33 h) (Fig. 4, see also Appendix B in Supplementary material).

#### 3.2. Validation

After calibration, we tested the model performance on five independent datasets. There were large differences between the recorded datasets, and the model was not able to reproduce all the patterns observed in nature (Fig. 5, see also Appendix B in Supplementary material). Furthermore, large variation among replicated simulations decreased model fits. The simulated distance moved from home and time between consecutive hauls were generally close to the average values observed in nature, and although there was a large variation in movement patterns among the satellite tracked animals, the range of values produced by the model were within the range of values observed for most satellite tracked animals. Still in the case of the *distance from home* pattern, there were statistically significant differences (one-way ANOVA,  $p < 0.05$ ) in all replicates compared to field datasets. The *moving duration* pattern was well reproduced for individuals HE07 and KJ07 (the number of replicates that did not statistically differ were 9 and 8 out of 10, respectively).

#### 3.3. Sensitivity analysis

The global sensitivity analysis showed that variations in *moving duration* were driven only by the exhaustion rate of adults, while the mean swimming speed of adults had the strongest effects on the variable *distance from home*. Interactions between parameters were more important in the latter variable (Fig. 6).

The number of haul out sites had a significant effect on both output variables (full factorial two-way ANOVA, *distance from home*;  $p < 0.001$ , *moving duration*;  $p < 0.001$ ). The distribution of haul out sites (random distribution at the initialisation of each replicate or same locations in all replicates) had a significant effect on *distance from home* pattern ( $p < 0.001$ ). There was no effect on *moving duration* ( $p = 0.104$ ). Furthermore, the interaction between the number and distribution of haul out sites had significant effects on both patterns (*distance from home*;  $p < 0.001$ , *moving duration*;  $p < 0.001$ ) (see also Appendix C in Supplementary material). In addition, the stochastic selection of haul out sites and deep water foraging areas during the warm-up period increased variability between replicates. The standard deviation of the mean was higher for both output variables when selection of haul out sites and deep water foraging areas were based on memory and distance factors (*distance from home*; 0.32 km, *moving duration*; 1.29 h) compared to simulations in which sites were predetermined (*distance from home*; 0.16 km, *moving duration*; 1.01 h). The coefficient of variation of *distance from home* and *moving duration* was 65.75% and 29.97%, respectively, when the sites were selected based on memory and distance factors, and 64.84% and 32.77%, respectively, when sites were predetermined (see also Appendix D in Supplementary material).

#### 3.4. Re-calibration and evaluation of model performance

A high degree of variation among satellite tracked animals resulted in deviations from the simulated tracks. We introduced individual variation and re-calibrated the *mean swimming speed* parameter for each dataset separately to improve the model fit on observed *distance from home* patterns, as we observed that the swimming speed parameter had the strongest effect on this pattern in the global sensitivity analysis. Re-calibrated mean speed values were: HE07–250 m/20 min, KJ07–350 m/20 min, OL10–100 m/20 min, TO09–190 m/20 min and VI09–100 m/20 min. After re-calibrating this parameter, the fit for both output variables improved. Regarding the *distance from home* variable, all five tested individuals had a reasonably good fit. In the case of *moving*

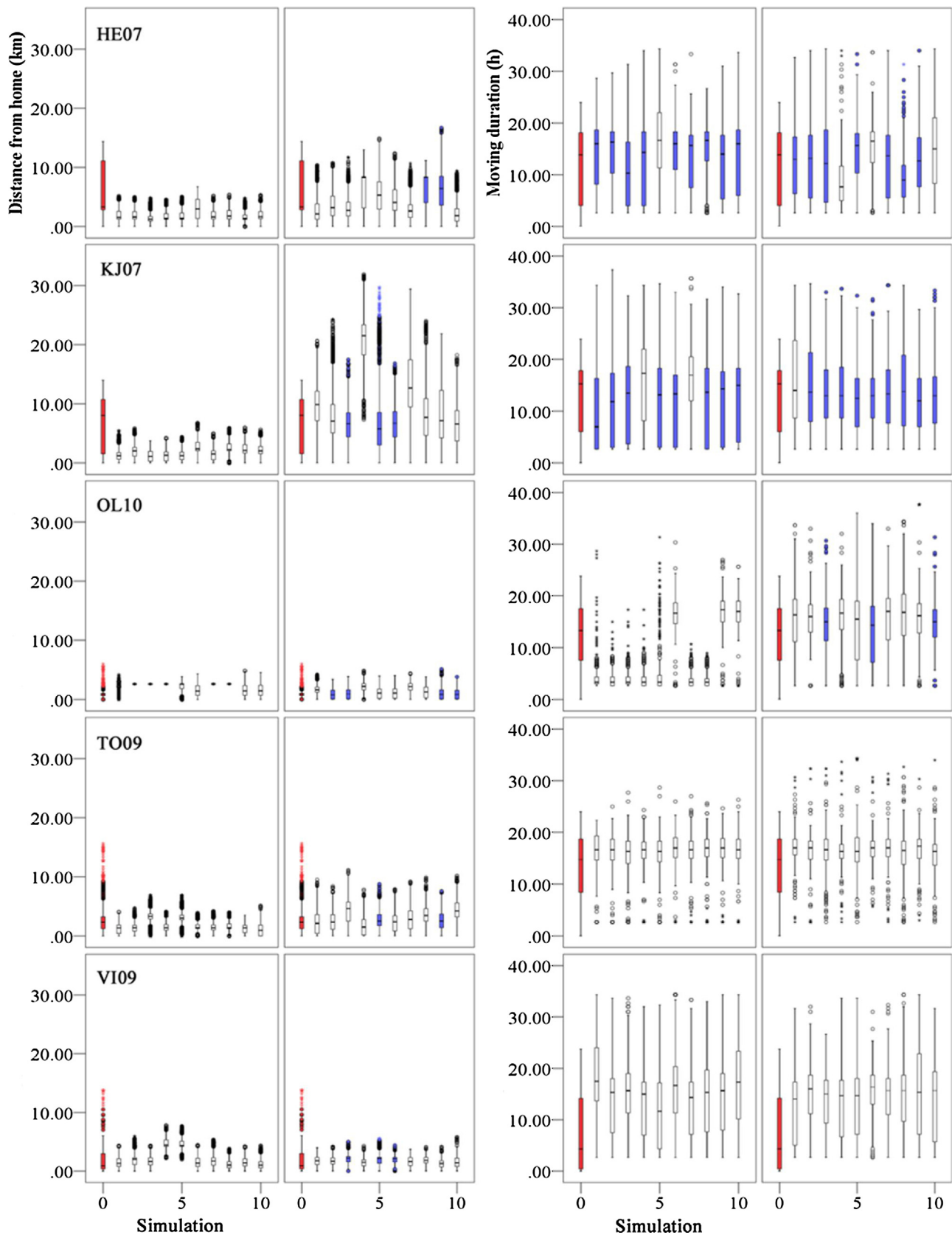

**Fig. 5.** Distance from home and moving duration of five GPS/GSM tracked Saimaa ringed seal individuals compared to 10 simulation replicates (0=observed data from five seal individuals (red colour), 1–10=simulation replicates). For both output variables, box plots on the left are based on calibration on one individual (ER11); boxplots on the right were obtained after recalibrating the mean speed parameter on an individual basis. Simulations with no statistical differences from observed data (one-way ANOVA,  $p > 0.05$ ) are marked with blue. ( $\circ$  = outliers  $1.5 \times$  inter quartile range (IQR) or more above the third quartile or  $1.5 \times$  IQR or more below the first quartile, \* = outliers  $3 \times$  IQR or more above the third quartile or  $3 \times$  IQR below the first quartile.). (For interpretation of the references to colour in this figure legend, the reader is referred to the web version of this article.)

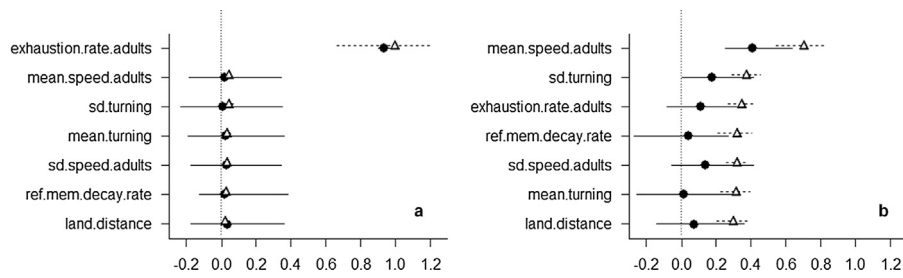

**Fig. 6.** Sensitivity analysis showing how (a) moving duration and (b) distance from home are influenced by changes in parameter values. ● = first-order indices ▲ = total-effect indices.

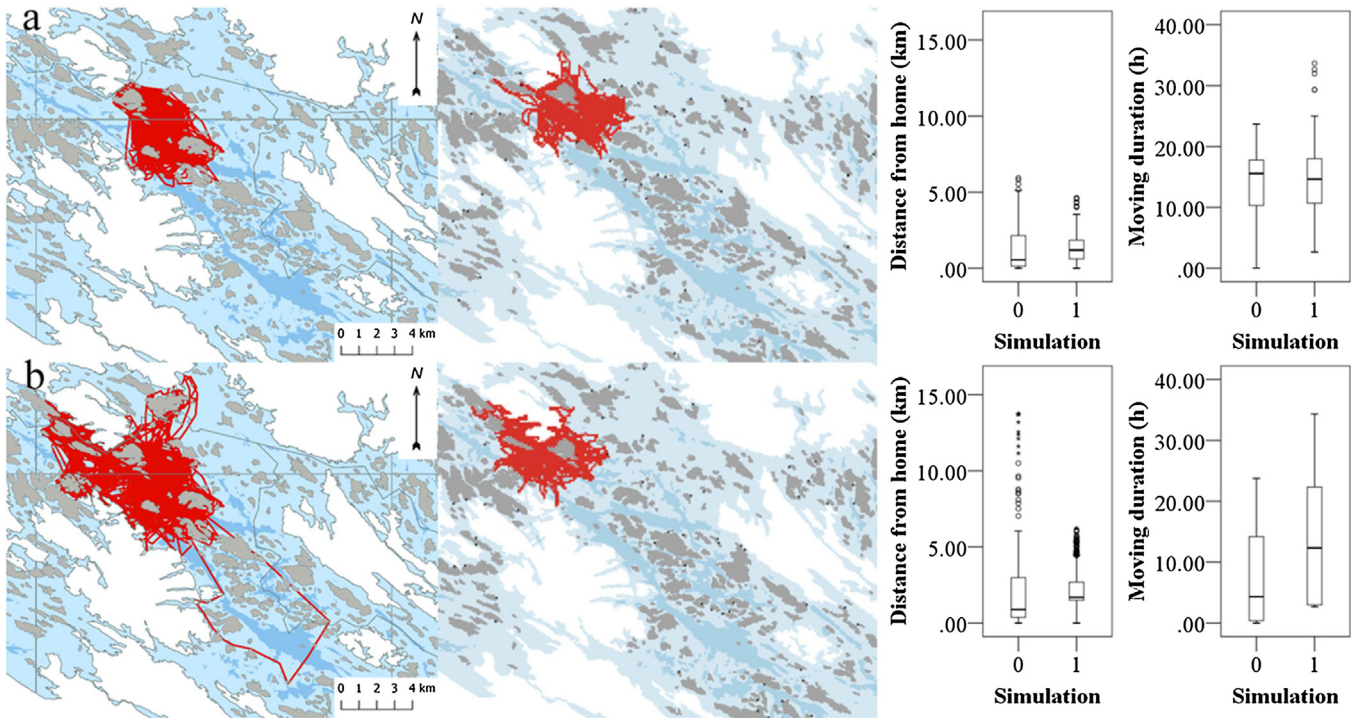

**Fig. 7.** Movement paths of Saimaa ringed seal individuals ER11 (a) and VI09 (b) on the left, and their corresponding simulations (one replicate) after re-calibration (see section 2.5 Parameterization) on the right. Box plots for the output variables, distance from home (km) and moving duration (h), are presented on the right (0 = observed data from seal individual, 1 = simulation replicate). (○ = outliers  $1.5 \times$  inter quartile range (IQR) or more above the third quartile or  $1.5 \times$  IQR or more below the first quartile.).

duration variable, the model reproduced patterns relatively well for three out of five tested datasets (Fig. 5, see also Appendix B in Supplementary material). For visualization purposes, we plotted the movement paths of individuals ER11 and VI09 compared to their corresponding simulations (Fig. 7).

#### 4. Discussion

We analysed existing telemetry datasets of six Saimaa ringed seals and used them to develop an individual-based movement model for adult seals. We based the model on assumptions regarding seal resting and foraging behaviour and their ability to memorise these sites. Our aim was to design and implement a seal movement model that could be further developed into a population model and used for evaluating efficiency of conservation measures. We analysed the model to test whether it could reproduce observed patterns of independent datasets that had not been used in model calibration. Furthermore, we tested its sensitivity to model assumptions and parameter uncertainty.

#### 4.1. Model structure, innovations and limitations

The model is based on correlated random walk, a classical approach for modelling animal movements. However, correlated random walks cause animals to gradually move away from their starting position; therefore it is not optimal for modelling compact home ranges. To enable the formation of home ranges similar to those observed in Saimaa ringed seal telemetry studies, we added spatial memory in the model. Nabe-Nielsen et al. (2013) applied the concept of spatial memory (Van Moorter et al., 2009) on the model of harbour porpoises (*Phocoena phocoena*) to allow them memorise high quality feeding grounds and previously visited areas. We used the approach to have seal memorise foraging areas and haul out sites it used. The seal remembers not only the locations of visited haul out sites, but also the time since the last visit. The seal prefers haul out sites that are nearby and recently visited, leading to the emergence of home ranges (Vincent et al., 2017). Nabe-Nielsen et al. (2013) applied their model in a fairly homogenous landscape, which is in accordance with many of the existing movement models. In contrast to earlier memory-based movement models, we

represented the environment in more detail. Spatial explicitness is especially important in models intended for management purposes (DeAngelis and Yurek, 2017). Lake Saimaa is a highly complex and labyrinthine environment (>13 000 islands) (Kuusisto, 1999) and at the same time, a large variation in home range sizes have been previously reported for the Saimaa ringed seal (Niemi et al., 2012). Therefore, we hypothesized that the complex nature of the landscape may explain some of the individual differences in home range size and shape. We developed and implemented a novel land avoidance procedure that is a key feature of our model (Dalleau, 2013). Land avoidance enables seal to bypass any land area it encounters while foraging.

Bioenergetics is an important feature of animal movement models and has been incorporated in detail in many IBMs (e.g. Bennett and Tang, 2006; Hölker and Breckling, 2005; Morales et al., 2005; Reuter and Breckling, 1999). We use exhaustion to model seal bioenergetics. The parameters were calibrated to match the movement patterns of one individual, as no ringed seal bioenergetics data is available. Implementing seal bioenergetics in more detail would likely result in more realistic presentation of the real system. First step for this could be addition of the existing dive data as diving behaviour unarguably has effect on the overall distance seal travels. In the current model version, we model only two-dimensional space use.

Some adult Saimaa ringed seal individuals stay within relatively small range while others take trips of tens of kilometres (Niemi et al., 2012). Because of this variation, capturing all these factors in a single value of parameters is a challenging task. Sex, age, body mass or other physical attributes were not considered in either model development or validation as it is not clear how these factors affect movement parameters of adult Saimaa ringed seals. Furthermore, it is not known to what extent the individuals' knowledge and experience of the environment affects their movement patterns. Older and more experienced individuals are likely to have more knowledge about the environment since Saimaa ringed seal are known to exhibit high site fidelity, which can affect their spatial behaviour. All data used in this study were obtained from individuals that were classified as adults based on their size. Even though sex-related variation have not been clearly reported in telemetry studies, genetic data show a sevenfold male-to-female gene flow ratio, indicating a larger scale of movement in males in the long term (Valtonen et al., 2014). Furthermore, sex- and body mass-related variations in movements are observed in grey seals (*Halichoerus grypus*) and ringed seals (Austin et al., 2004; Beck et al., 2003), but no clear patterns are reported for Saimaa ringed seals. In general, body mass correlates positively with the extent of movements in mammals (Harestad and Bunnell, 1979; Lindstedt et al., 1986; Swihart et al., 1988). Nevertheless, Saimaa ringed seal movement patterns vary among individuals depending on their state, but such variations are not included in this model. Adding such variations might help explaining the difference in the movement patterns between satellite tracked and simulated seals.

In addition to biological factors, uncertainty and lack of environmental variables in the model may have impaired the performance. Location and number of haul out sites in Lake Saimaa may vary from one year to another due to water level fluctuations. Therefore, our estimates on haul out site number and location are not necessarily accurate which might have affected the model performance. Nevertheless, the number of haul out sites implemented in the model is in accordance with Niemi et al. (2013a) who observed eight GPS/GSM tagged seal to occupy 104 haul out sites in total in same study region. In addition to the uncertainty related to haul out sites, it is likely that e.g., disturbance, quality of surrounding environment in terms of foraging areas, lair sites, and mating partners, affect the space use of the seals in the real environment. In order to improve the model fit, data on environmental

factors possibly affecting seal movement patterns should be collected and implemented in the model (Schick et al., 2008) as such data is non-existent currently. Likewise, the selection and change of haul-out sites can be affected by anthropogenic disturbances (e.g., boat passing by); data on the frequency of such disturbances could increase the fit of our model to movement data.

#### 4.2. Model parameterization and validation

We used pattern-oriented calibration to find the best parameterization of the model. However, simulations run with the optimal parameter set yielded a poor fit to the independent telemetry datasets used for validation; the model was not able to reproduce the *distance from home* patterns recorded in the field, which were highly variable between tracked seals.

The Saimaa ringed seal shows large intraspecific variability in movement patterns and spatial ecology (Niemi et al., 2012); particularly, our field datasets revealed strong variations across individuals in their swimming performance, which has a strong effect on the movement distances simulated by our model. To implement the intraspecific variability in swimming performance observed in nature in our model, we re-calibrated the mean swimming speed parameter on an individual basis using data from the five individuals that we initially used for validation, which led to a significant improvement in model performance. Furthermore, we observed large variability in exhaustion rates between seals; therefore, calibration of the *exhaustion-rate* parameter on an individual basis would likely result in a better fit for the moving duration pattern, as this parameter was observed to have the strongest effect on the pattern.

The large variability in the mean swimming speed of adult seals cannot be captured with a single fixed value. In consequence, for the future evolution of this movement model into a population model targeted at predicting seal population dynamics, a probability distribution for the *mean-speed-adults* parameter may be implemented. We thus developed the probability distribution based on re-calibration results and observed field data to account for such individual variability (see Appendix E in Supplementary material). Morales et al. (2004) suggested a similar approach for their elk (*Cervus elaphus*) movement model, which was also developed with a small data set. Ultimately, the probability distribution of seal movement speed should be obtained from as many individuals as possible to improve model fit and to overcome the issue caused by large intraspecific variation. In addition, identification of the factors influencing seal spatial behaviour would be beneficial.

Seals are highly cognitive mammals and their behaviour is likely affected by many processes that we cannot identify using telemetry data alone. Using simple movement data for calibrating a model of such cognitively competent animals living in highly heterogeneous environment is challenging. Morales et al. (2004) observed that simple correlated random walk based movement model is too simple for predicting elk movements. Better match to observed datasets was achieved with a model that included multiple movement states, i.e. multiple correlated random walks that each have different parameter distributions. Our model would benefit if more information on seal behaviour could be connected to observed individual characteristics or environmental factors. For the future development of our Saimaa ringed seal model, it would be beneficial to identify these seal behavioural states, which could be then implemented in the model, thus improving the fit. Identifying individual movement patterns and the motivation behind them, would also benefit movement ecology study in general as this aspect is neglected in many cases (Holyoak et al., 2008).

#### 4.3. Model sensitivity

The mean swimming speed had the strongest influence on the distance moved by adult seal from the initial position and thus on the size of its home range. On the other hand, exhaustion rate was the main and basically the only driver of the time passed between haul outs. The quicker the seal gets exhausted, the less time it spends foraging before needing to rest on a haul out site.

In addition to seal-related parameters, we estimated the sensitivity of movement patterns to environmental factors. The higher number of haul out sites we implement in the model, the greater is the simulated distance from home and the shorter are the time periods that seals move between consecutive haul out events. Site selection is partly based on distance to the visited sites, which explains the effect of the number of haul out sites on movement patterns to some extent. Furthermore, increasing the availability of haul out sites increases the probability that the seal has a rest even if it is not exhausted. Consequently, the time spent foraging between consecutive haul out events shortens.

Moreover, the selection of haul out sites and foraging areas used during the warm-up period increases variation between model replicates. The model is run for 12.5 months before collecting the results, so the seal develops a memory of certain foraging areas and resting sites that are selected in a random way, thus introducing variability among model runs.

#### 4.4. Model application and outlook

This paper describes a model predicting Saimaa ringed seal movement behaviour. We started with a simple hypothesis, where we assumed the complexity of the landscape would explain the variation in home range size among the individuals. However, the differences in the landscape were not sufficient to explain the observed movement patterns. Therefore, the model would benefit from further variables, adding some more biological and environmental aspects that affect seal behaviour. More studies are needed to find the underlying mechanisms of the observed movement patterns. However, the current model version forms a sound basis for further development. Ultimate implementation of seals' full life cycle and interactions between individuals in the model would enable the analysis of population dynamics under changing environmental conditions and conservation and management scenarios. One of the major factors causing mortality in Saimaa ringed seals is bycatch in gillnet fishing (Kovacs et al., 2012); therefore, fishing restrictions have been applied in the most important breeding areas. Despite these restrictions, bycatch mortality has remained relatively high (Auttila, 2015; Kunnasranta et al., 2016), and therefore, there is a demand to extend the restrictions both temporally and spatially. Although, the current model version has to be considered preliminary, and several improvements could be considered, an application of the model could be used to study the effects of different fishing restriction scenarios, which would provide much needed information on the effectiveness of mitigation methods.

#### Acknowledgements

We thank Lauri Mehtätalo, Anssi Vainikka, and two anonymous reviewers for their invaluable comments and suggestions on earlier versions of this manuscript. We are thankful to the Maj and Tor Nessling foundation, Raija and Ossi Tuuliainen foundation, and University of Eastern Finland for funding this study.

#### Appendix A. Supplementary data

Supplementary data associated with this article can be found, in the online version, at <https://doi.org/10.1016/j.ecolmodel.2017.12.002>.

#### References

- Arrignon, F., Deconchat, M., Sarthou, J.-P., Balent, G., Monteil, C., 2007. Modelling the overwintering strategy of a beneficial insect in a heterogeneous landscape using a multi-agent system. *Ecol. Model.* 205, 423–436.
- Augusiak, J., Van den Brink, P.J., Grimm, V., 2014. Merging validation and evaluation of ecological models to 'evaluation': a review of terminology and a practical approach. *Ecol. Model.* 280, 117–128.
- Austin, D., Bowen, W.D., McMillan, J.I., 2004. Intraspecific variation in movement patterns: modeling individual behaviour in a large marine predator. *Oikos* 105, 15–30.
- Auttila, M., Niemi, M., Skrzypczak, T., Viljanen, M., Kunnasranta, M., 2014. Estimating and mitigating perinatal mortality in the endangered saimaa ringed seal (*Phoca hispida saimensis*) in a changing climate. *Ann. Zool. Fenn.* 51, 526–534.
- Auttila, M., Sinisalo, T., Valtonen, M., Niemi, M., Viljanen, M., Kurkilahti, M., Kunnasranta, M., 2015. Diet composition and seasonal feeding patterns of a freshwater ringed seal (*Pusa hispida saimensis*). *Mar. Mamm. Sci.* 31, 45–65.
- Auttila, M., Kurkilahti, M., Niemi, M., Levänen, R., Sipilä, T., Isomursu, M., Koskela, J., Kunnasranta, M., 2016. Morphometrics, body condition, and growth of the ringed seal (*Pusa hispida saimensis*) in Lake Saimaa: implications for conservation. *Mar. Mamm. Sci.* 32, 252–267.
- Auttila, M., 2015. The Endangered Saimaa Ringed Seal in a Changing Climate – Challenges for Conservation and Monitoring. Publications of the University of Eastern Finland, Dissertations in Forestry and Natural Sciences, pp. 194.
- Auvinen, H., Jurvelius, J., Koskela, J., Sipilä, T., 2005. Comparative use of vendace by humans and Saimaa ringed seal in Lake Pihlajavesi, Finland. *Biol. Conserv.* 125, 381–389.
- Ball, J.P., Nordengren, C., Wallin, K., 2001. Partial migration by large ungulates: characteristics of seasonal moose *Alces alces* ranges in northern Sweden. *Wildl. Biol.* 7, 39–47.
- Beck, C.A., Bowen, W.D., McMillan, J.I., Iverson, S.J., 2003. Sex differences in diving at multiple temporal scales in a size-dimorphic capital breeder. *J. Anim. Ecol.* 72, 979–993.
- Bennett, D.A., Tang, W., 2006. Modelling adaptive, spatially aware, and mobile agents: Elk migration in Yellowstone. *Int. J. Geogr. Inf. Sci.* 20, 1039–1066.
- Boily, P., 1995. Theoretical heat flux in water and habitat selection of phocid seals and beluga whales during the annual molt. *J. Theor. Biol.* 172, 235–244.
- Born, E.W., Teilmann, J., Acquarone, M., Riget, F.F., 2004. Habitat use of ringed seals (*Phoca hispida*) in the north water area (North Baffin Bay). *Arctic* 57 (2004), 14.
- Calenge, C., 2011. Analysis of Animal Movements in R: the adehabitatLT Package.
- Carlens, H., Lydersen, C., Krafft, B.A., Kovacs, K.M., 2006. Spring haul-out behavior of ringed seals (*Pusa hispida*) in Kongsfjorden, Svalbard. *Mar. Mamm. Sci.* 22, 379–393.
- Chudzińska, M.E., Nabe-Nielsen, J., Nolet, B.A., Madsen, J., 2016. Foraging behaviour and fuel accumulation of capital breeders during spring migration as derived from a combination of satellite- and ground-based observations. *J. Avian Biol.* 47, 563–574.
- Dalleau, M., 2013. Ecologie spatiale des tortues marines dans le Sud-ouest de l'océan Indien. Apport de la géomatique et de la modélisation pour la conservation. Thèse de doctorat. Université de La Réunion (p. 330).
- DeAngelis, D.L., Grimm, V., 2014. Individual-based models in ecology after four decades. *F1000Prime Rep.* 6, 39.
- DeAngelis, D.L., Yurek, S., 2017. Spatially explicit modeling in ecology: a review. *Ecosystems* 20, 284–300.
- Eisinger, D., Thulke, H.-H., 2008. Spatial pattern formation facilitates eradication of infectious diseases. *J. Appl. Ecol.* 45, 415–423.
- Eisinger, D., Thulke, H.-H., Selhorst, T., Müller, T., 2005. Emergency vaccination of rabies under limited resources – combating or containing? *BMC Infect. Dis.* 5, 1–16y.
- Fagan, W.F., Calabrese, J.M., 2014. The correlated random walk and the rise of movement ecology. *Bull. Ecol. Soc. Am.* 95, 204–206.
- Fleming, C.H., Calabrese, J.M., Mueller, T., Olson, K.A., Leimgruber, P., Fagan, W.F., 2014. Non-Markovian maximum likelihood estimation of autocorrelated movement processes. *Methods Ecol. Evol.* 5, 462–472.
- Fleming, C.H., Fagan, W.F., Mueller, T., Olson, K.A., Leimgruber, P., Calabrese, J.M., 2015. Rigorous home range estimation with movement data: a new autocorrelated kernel density estimator. *Ecology* 96, 1182–1188.
- Gramacy, R.B., Taddy, M., 2010. Categorical inputs, sensitivity analysis, optimization and importance tempering with tgp version 2, an R package for treed Gaussian process models. *J. Stat. Softw.* 33, 1–48.
- Gramacy, R.B., 2007. tgp: an R package for Bayesian nonstationary, semiparametric nonlinear regression and design by treed Gaussian process models. *J. Stat. Softw.* 19, 6.
- Grimm, V., Berger, U., 2016. Structural realism, emergence, and predictions in next-generation ecological modelling: synthesis from a special issue. *Ecol. Model.* 326, 177–187.

- Grimm, V., Railsback, S.F., 2012. Pattern-oriented modelling: a 'multi-scope' for predictive systems ecology. *Phil. Trans. R. Soc. B: Biol. Sci.* 367, 298–310.
- Grimm, V., Revilla, E., Berger, U., Jeltsch, F., Mooij, W.M., Railsback, S.F., Thulke, H.-H., Weiner, J., Wiegand, T., DeAngelis, D.L., 2005. Pattern-oriented modeling of agent-based complex systems: lessons from ecology. *Science* 310, 987–991.
- Grimm, V., Berger, U., Bastiansen, F., Eliassen, S., Ginot, V., Giske, J., Goss-Custard, J., Grand, T., Heinz, S.K., Huse, G., Huth, A., Jepsen, J.U., Jørgensen, C., Mooij, W.M., Müller, B., Pe'er, G., Piou, C., Railsback, S.F., Robbins, A.M., Robbins, M.M., Rossmanith, E., Rügen, N., Strand, E., Souissi, S., Stillman, R.A., Vabø, R., Visser, U., DeAngelis, D.L., 2006. A standard protocol for describing individual-based and agent-based models. *Ecol. Model.* 198, 115–126.
- Grimm, V., Berger, U., DeAngelis, D.L., Polhill, J.G., Giske, J., Railsback, S.F., 2010. The ODD protocol: a review and first update. *Ecol. Model.* 221, 2760–2768.
- Grimm, V., Augustiak, J., Focks, A., Frank, B.M., Gabsi, F., Johnson, A.S.A., Liu, C., Martin, B.T., Meli, M., Radchuk, V., Thorbek, P., Railsback, S.F., 2014. Towards better modelling and decision support: documenting model development, testing, and analysis using TRACE. *Ecol. Model.* 280, 129–139.
- Höjesjö, J., Økland, F., Sundström, L.F., Pettersson, J., Johnsson, J.L., 2007. Movement and home range in relation to dominance; a telemetry study on brown trout *Salmo trutta*. *J. Fish Biol.* 70, 257–268.
- Hölker, F., Breckling, B., 2005. A spatiotemporal individual-based fish model to investigate emergent properties at the organismal and the population level. *Ecol. Model.* 186, 406–426.
- Hake, M., Kjellén, N., Alerstam, T., 2001. Satellite tracking of Swedish Ospreys *Pandion haliaetus*: autumn migration routes and orientation. *J. Avian Biol.* 32, 47–56.
- Harestad, A.S., Bunnell, F., 1979. Home range and body weight—a reevaluation. *Ecology* 60, 389–402.
- Hart, K.M., Hyrenbach, K.D., 2009. Satellite telemetry of marine megavertebrates: the coming of age of an experimental science. *Endangered Species Res.* 10, 9–20.
- Hedin, J., Ranius, T., 2002. Using radio telemetry to study dispersal of the beetle *Osmoderma eremita*, an inhabitant of tree hollows. *Comput. Electron. Agric.* 35, 171–180.
- Helle, E., Hyvärinen, H., Sipilä, T., 1984. 1984: Breeding habitat and lair structure of the Saimaa ringed seal *Phoca hispida saimensis* Nordq. in Finland. *Acta Zool. Fennica* 172, 125–127.
- Holyoak, M., Casagrandi, R., Nathan, R., Revilla, E., Spiegel, O., 2008. Trends and missing parts in the study of movement ecology. *Proc. Natl. Acad. Sci.* 105, 19060–19065.
- Hyvärinen, H., Hämäläinen, E., Kunnasranta, M., 1995. Diving behavior of the Saimaa ringed seal (*Phoca hispida saimensis* Nordq.). *Mar. Mamm. Sci.* 11, 324–334.
- Iványi, M., Beckman, R., Conower, W., 1979. A comparison of three methods for selecting values of input variables in the analysis of output from a computer code. *Technometrics* 21, 239–245.
- Jansen, M.J.W., 1999. Analysis of variance designs for model output. *Comput. Phys. Commun.* 117, 35–43.
- Kelly, B., Badajos, O., Kunnasranta, M., Moran, J., Martinez-Bakker, M., Wartzok, D., Boveng, P., 2010. Seasonal home ranges and fidelity to breeding sites among ringed seals. *Polar Biol.* 33, 1095–1109.
- Koivuniemi, M., Auttila, M., Niemi, M., Levänen, R., Kunnasranta, M., 2016. Photo-ID as a tool for studying and monitoring the endangered Saimaa ringed seal. *Endangered Species Res.* 30, 29–36.
- Kokko, H., Lindström, J., Ranta, E., Sipilä, T., Koskela, J., 1998. Estimating the demographic effective population size of the Saimaa ringed seal (*Phoca hispida saimensis* Nordq.). *Anim. Conserv.* 1, 47–54.
- Kokko, H., Helle, E., Lindström, J., Ranta, E., Sipilä, T., Courchamp, F., 1999. Backcasting population sizes of ringed and grey seals in the Baltic and Lake Saimaa during the 20th century. *Ann. Zool. Fenn.* 36, 65–73.
- Koskela, J., Kunnasranta, M., Hämäläinen, E., Hyvärinen, H., 2002. Movements and use of haul-out sites of radio-tagged Saimaa ringed seal (*Phoca hispida saimensis* Nordq.) during the open-water season. *Ann. Zool. Fenn.* 39, 59–67.
- Kovacs, K.M., Aguilar, A., Aurioules, D., Burkanov, V., Campagna, C., Gales, N., Gelatt, T., Goldsworthy, S.D., Goodman, S.J., Hofmeyr, G.J.G., Härkönen, T., Lowry, L., Lydersen, C., Schipper, J., Sipilä, T., Southwell, C., Stuart, S., Thompson, D., Trillmich, F., 2012. Global threats to pinnipeds. *Mar. Mamm. Sci.* 28, 414–436.
- Kunnasranta, M., Hyvärinen, H., Sipilä, T., Koskela, J., 1999. The diet of the Saimaa ringed seal *Phoca hispida saimensis*. *Acta Theriol. (Warsz.)* 44, 443–450.
- Kunnasranta, M., Hyvärinen, H., Häkkinen, J., Koskela, J., 2002. Dive types and circadian behaviour patterns of Saimaa ringed seals *Phoca hispida saimensis* during the open-water season. *Acta Theriol. (Warsz.)* 47, 63–72.
- Kunnasranta, M., Niemi, M., Auttila, M., 2016. Saimaanorpan suojelubiologiaa: tutkimuksista toimenpiteisiin. *Suomen Riista* 62, 71–82.
- Kunnasranta, M., 2001. Behavioural Biology of Two Ringed Seal (*Phoca hispida*) Subspecies in the Large European Lakes Saimaa and Ladoga. University of Joensuu, pp. 86 (PhD Dissertations in Biology, No: 7. ISSN 1457–2486).
- Kuusisto, E., 1999. Elävä Saimaa. Tammi, Helsinki, pp. 205.
- López-Alfaró, C., Estades, C.F., Aldridge, D.K., Gill, R.M.A., 2012. Individual-based modeling as a decision tool for the conservation of the endangered huemul deer (*Hippocamelus bisulcus*) in southern Chile. *Ecol. Model.* 244, 104–116.
- Linard, C., Ponçon, N., Fontenille, D., Lambin, E.F., 2009. A multi-agent simulation to assess the risk of malaria re-emergence in southern France. *Ecol. Model.* 220, 160–174.
- Lindstedt, S.L., Miller, B.J., Buskirk, S.W., 1986. Home range, time, and body size in mammals. *Ecology* 67, 413–418.
- Liu, C., Sibly, R.M., Grimm, V., Thorbek, P., 2013. Linking pesticide exposure and spatial dynamics: an individual-based model of wood mouse (*Apodemus sylvaticus*) populations in agricultural landscapes. *Ecol. Model.* 248, 92–102.
- Liukko, U.-M., Henttonen, H., Hanski, I.K., Kauhala, K., Kojola, I., Kyheröinen, E.-M., Pitkänen, J., 2016. Suomen nisäkkäiden uhanalaisuus 2015. Erillisjulkaisu.
- Liukkonen, L., Rautio, A., Sipilä, T., Niemi, M., Auttila, M., Koskela, J., Kunnasranta, M., 2017. Long-term effects of land use on perinatal mortality in the Endangered Saimaa ringed seal population. *Endangered Species Res.* 34, 283–291.
- Metsähallitus, Parks & Wildlife Finland, 2016. Hyljekanta 2016, Available at <http://www.metsa.fi/saimaannorppa/hyljekanta2016>. (Accessed 25 August 2017).
- Morales, J.M., Haydon, D.T., Frair, J., Holsinger, K.E., Fryxell, J.M., 2004. Extracting more out of relocation data: building movement models as mixtures of random walks. *Ecology* 85, 2436–2445.
- Morales, J.M., Fortin, D., Frair, J.L., Merrill, E.H., 2005. Adaptive models for large herbivore movements in heterogeneous landscapes. *Landscape Ecol.* 20, 301–316.
- Morales, J.M., Moorcroft, P.R., Matthiopoulos, J., Frair, J.L., Kie, J.G., Powell, R.A., Merrill, E.H., Haydon, D.T., 2010. Building the bridge between animal movement and population dynamics. *Philos. Trans. R. Soc. B: Biol. Sci.* 365, 2289–2301.
- Moulton, V.D., Richardson, W.J., McDonald, T.L., Elliott, R.E., Williams, M.T., 2002. Factors influencing local abundance and haulout behaviour of ringed seals (*Phoca hispida*) on landfast ice of the Alaskan Beaufort Sea. *Can. J. Zool.* 80, 1900–1917.
- Moulton, V.D., Richardson, W.J., Elliott, R.E., McDonald, T.L., Nations, C., Williams, M.T., 2005. Effects of an offshore oil development on local abundance and distribution of ringed seals (*Phoca hispida*) of the Alaskan Beaufort Sea. *Mar. Mamm. Sci.* 21, 217–242.
- Nabe-Nielsen, J., Sibly, R.M., Forchhammer, M.C., Forbes, V.E., Topping, C.J., 2010. The effects of landscape modifications on the long-term persistence of animal populations. *PLoS One* 5, e8932.
- Nabe-Nielsen, J., Tougaard, J., Teilmann, J., Lucke, K., Forchhammer, M.C., 2013. How a simple adaptive foraging strategy can lead to emergent home ranges and increased food intake. *Oikos* 122, 1307–1316.
- Nathan, R., Getz, W.M., Revilla, E., Holyoak, M., Kadmon, R., Saltz, D., Smouse, P.E., 2008. A movement ecology paradigm for unifying organismal movement research. *Proc. Natl. Acad. Sci.* 105, 19052–19059.
- Niemi, M., Auttila, M., Viljanen, M., Kunnasranta, M., 2012. Movement data and their application for assessing the current distribution and conservation needs of the endangered Saimaa ringed seal. *Endangered Species Res.* 19, 99–108.
- Niemi, M., Auttila, M., Valtonen, A., Viljanen, M., Kunnasranta, M., 2013a. Haulout patterns of Saimaa ringed seals and their response to boat traffic during the moulting season. *Endangered Species Res.* 22, 115–124.
- Niemi, M., Auttila, M., Viljanen, M., Kunnasranta, M., 2013b. Home range, survival, and dispersal of endangered Saimaa ringed seal pups: implications for conservation. *Mar. Mamm. Sci.* 29, 1–13.
- Niemi, M., 2013. Behavioural ecology of the Saimaa ringed seal – implications for conservation. *Dissert. For. Nat. Sci.* 129.
- Nyman, T., Valtonen, M., Aspi, J., Ruokonen, M., Kunnasranta, M., Palo, J.U., 2014. Demographic histories and genetic diversities of Fennoscandian marine and landlocked ringed seal subspecies. *Ecol. Evol.* 4, 3420–3434.
- Oksanen, S.M., Niemi, M., Ahola, M.P., Kunnasranta, M., 2015. Identifying foraging habitats of Baltic ringed seals using movement data. *Mov. Ecol.* 3, 33.
- Paterson, W., Sparling, C.E., Thompson, D., Pomeroy, P.P., Currie, J.L., McCafferty, D.J., 2012. Seals like it hot: changes in surface temperature of harbour seals (*Phoca vitulina*) from late pregnancy to moult. *J. Therm. Biol.* 37, 454–461.
- Pauli, B.P., McCann, N.P., Zollner, P.A., Cummings, R., Gilbert, J.H., Gustafson, E.J., 2013. SEARCH: spatially explicit animal response to composition of habitat. *PLoS One* 8, e64656.
- Pujol, G., Iooss, B., Janon, A., 2016. Global Sensitivity Analysis of Model Outputs. R Development Core Team, 2011. R: a Language and Environment for Statistical Computing. R Foundation for Statistical Computing, Vienna.
- Railsback, S.F., Grimm, V., 2012. Agent-based and Individual-based Modeling: a Practical Introduction. Princeton University Press, Princeton, NJ.
- Railsback, S.F., Lamberson, R.H., Harvey, B.C., Duffy, W.E., 1999. Movement rules for individual-based models of stream fish. *Ecol. Model.* 123, 73–89.
- Rautio, A., Valtonen, A., Kunnasranta, M., 2013. The effects of sex and season on home range in European hedgehogs at the northern edge of the species range. *Ann. Zool. Fenn.* 50, 107–123.
- Reuter, H., Breckling, B., 1999. Emerging properties on the individual level: modelling the reproduction phase of the European robin *Erithacus rubecula*. *Ecol. Model.* 121, 199–219.
- Saltelli, A., Annoni, P., Azzini, I., Campolongo, F., Ratto, M., Tarantola, S., 2010. Variance based sensitivity analysis of model output: design and estimator for the total sensitivity index. *Comput. Phys. Commun.* 181, 259–270.
- Schick, R.S., Loarie, S.R., Colchero, F., Best, B.D., Boustany, A., Conde, D.A., Halpin, P.N., Joppa, L.N., McClellan, C.M., Clark, J.S., 2008. Understanding movement data and movement processes: current and emerging directions. *Ecol. Lett.* 11, 1338–1350.
- Schmolke, A., Thorbek, P., DeAngelis, D.L., Grimm, V., 2010. Ecological models supporting environmental decision making: a strategy for the future. *Trends Ecol. Evol.* 25, 479–486.
- Schwarzkopf, L., Alford, R.A., 2002. Nomadic movement in tropical toads. *Oikos* 96, 492–506.

- Sipilä, T., 2003. *Conservation Biology of Saimaa Ringed Seal (Phoca hispida Saimensis) with Reference to Other European Seal Populations*. PhD Dissertation.
- Sobol, W., 1993. Analysis of variance for 'component stripping' decomposition of multiexponential curves. *Comput. Methods Programs Biomed.* 39, 243–257.
- Swihart, R.K., Slade, N.A., Bergstrom, B.J., 1988. Relating body size to the rate of home range use in mammals. *Ecology* 69, 393–399.
- Thulke, H.H., Eisinger, D., 2008. The strength of 70%: revision of a standard threshold of rabies control. *Dev. Biol. (Basel)*, 291–298.
- Valkeajärvi, P., Auvinen, H., Riikonen, R., 2010. Muikkukannat 2009–2010. Muikun, ahvenen, kuoreen, siian ja särjen runsaus lähes sadassa järvessä. Riista- ja kalatalous –selvityksiä (12/2010).
- Valtonen, M., Palo, J., Ruokonen, M., Kunnasranta, M., Nyman, T., 2012. Spatial and temporal variation in genetic diversity of an endangered freshwater seal. *Conserv. Genet.* 13, 1231–1245.
- Valtonen, M., Palo, J.U., Aspi, J., Ruokonen, M., Kunnasranta, M., Nyman, T., 2014. Causes and consequences of fine-scale population structure in a critically endangered freshwater seal. *BMC Ecol.* 14, 22–22.
- Van Moorter, B., Visscher, D., Benhamou, S., Börger, L., Boyce, M.S., Gaillard, J.-M., 2009. Memory keeps you at home: a mechanistic model for home range emergence. *Oikos* 118, 641–652.
- Vincent, C., Huon, M., Caurant, F., Dabin, W., Deniau, A., Dixneuf, S., Dupuis, L., Elder, J.-F., Fremau, M.-H., Hassani, S., Hemon, A., Karpouzopoulos, J., Lefeuvre, C., McConnell, B.J., Moss, S.E.W., Provost, P., Spitz, J., Turpin, Y., Ridoux, V., 2017. Grey and harbour seals in France: distribution at sea: connectivity and trends in abundance at haulout sites. *Deep Sea Res. Part II* 141, 294–305.
- Wabakken, P., Sand, H., Kojola, I., Zimmermann, B., Arnemo, J.M., Pedersen, H.C., Liberg, O., 2007. Multistage, long-range natal dispersal by a global positioning system-collared scandinavian wolf. *J. Wildl. Manage.* 71, 1631–1634.
- Wiegand, T., Jeltsch, F., Hanski, I., Grimm, V., 2003. Using pattern-oriented modeling for revealing hidden information: a key for reconciling ecological theory and application. *Oikos* 100, 209–222.
- Wiegand, T., Revilla, E., Knauer, F., 2004. Dealing with uncertainty in spatially explicit population models. *Biodivers. Conserv.* 13, 53–78.
- Wilensky, U., 1999. NetLogo. Center for Connected Learning and Computer-Based Modeling. Northwestern University, Evanston, IL <http://ccl.northwestern.edu/netlogo/>.